

# KOBELCO

SK500XDLC/SK520XDLC-10

## SK500XD<sub>LC</sub> SK520XD<sub>LC</sub>

■ **Bucket Capacity :**

1.9 – 3.4 m<sup>3</sup> (ISO heaped)

■ **Engine Power :**

257 kW/1,850 min<sup>-1</sup> (ISO 14396)

■ **Operating Weight :**

52,100 – 53,700 kg



**We Save You Fuel**  
Achieving a Low-Carbon Society



# Extra Heavy Duty

Built for the most extreme work environments, KOBELCO XD Series excavators feature a rugged machine body with comprehensive additional reinforcement across the boom, arm and undercarriage, for a machine that will stand up to the most demanding work. Built to KOBELCO's world renowned standards of Japanese quality and reliability, it all adds up to KOBELCO's toughest heavy excavator ever.

KOBELCO's advanced hydraulic technology delivers the ultimate in power and efficiency, giving you uncompromising performance, while delivering KOBELCO's proven low fuel consumption to benefit your bottom line. The SK500XDLC/SK520XDLC has been built to meet the needs of the most punishing sites with superior digging performance and productivity that simply astounds.









# Next-Level Strength & Durability

Built to Operate in Tough Working Environments

## Hydraulic Drive for Engine Cooling Fan; **NEW** Independent Oil Cooler Fan

Hydraulic drive optimises the cooling fan rotation speed to improve fuel economy and reduce noise. The independent oil cooler fan better matches cooling to the hydraulic oil temperature, for optimal oil temperature control.

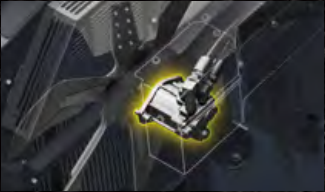

Cooling fan for inter cooler & radiator.



Cooling fan for oil cooler.



## Upper Under Covers **NEW**

Thick covers with increased durability compared to SK500LC-9.

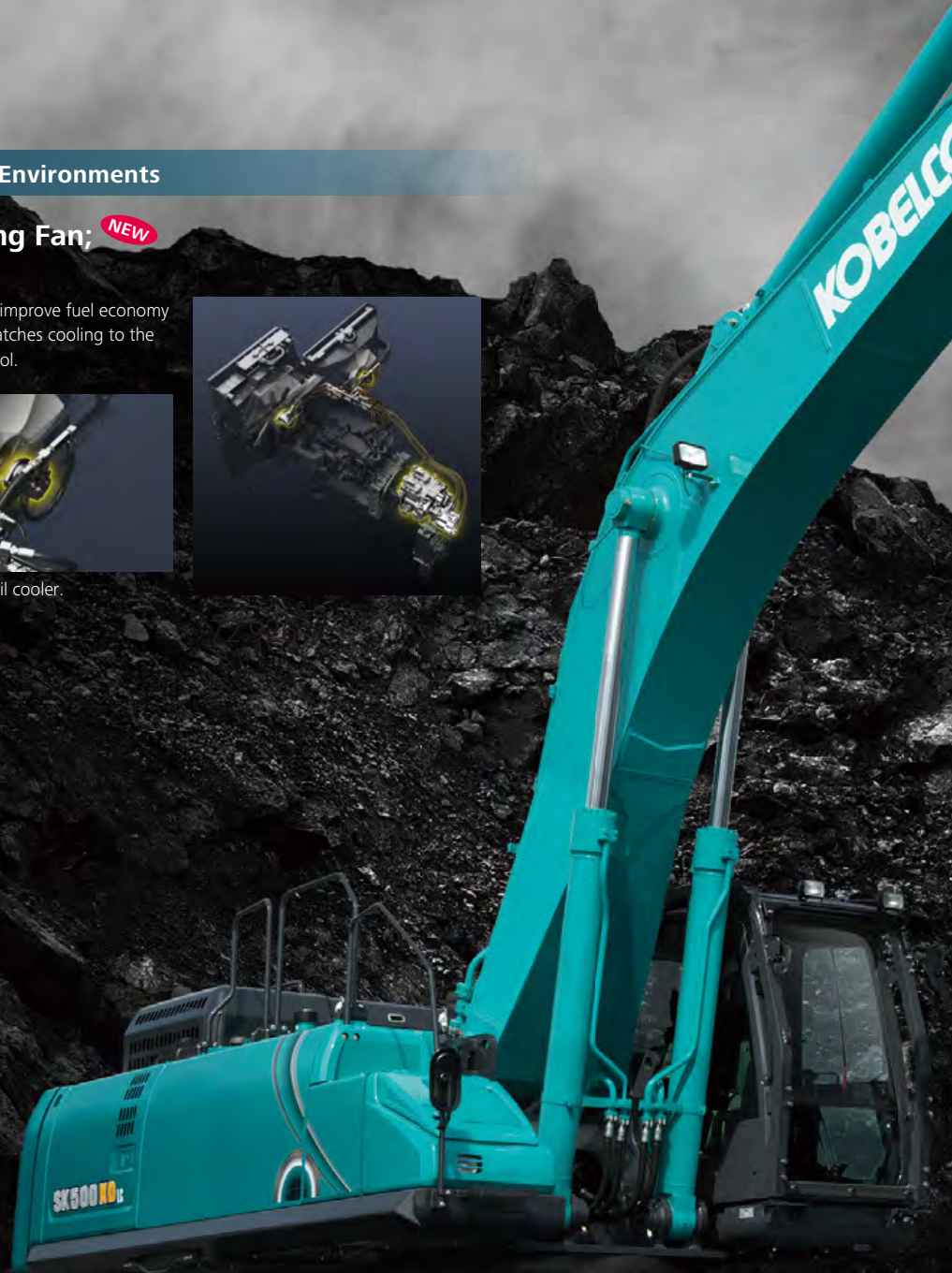





### Boom and Arm Reinforced for Extreme Conditions

#### Piping for Quick Hitch

A quick hitch hydraulic line, which speeds up attachment changes, is available. (For SK500XDLC only)

#### Rock Guards **NEW**

Specially designed long, solid rock guard installed to prevent damage to arm.

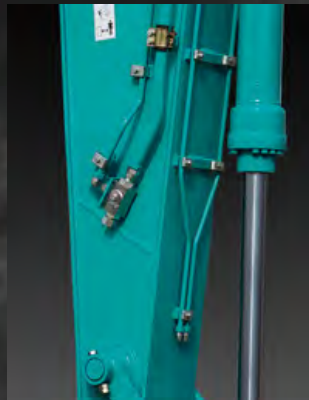

### Reinforced arm exhibits strength

Thickness of steel plate for arm top and arm foot has been increased to deliver more strength for toughest working conditions.

#### XD arm **NEW**



Arm top



Arm foot

### Newly developed boom made of thicker steel plate

The XD boom features reinforcement plates, which increases longevity even under the toughest working conditions.

#### XD boom **NEW**

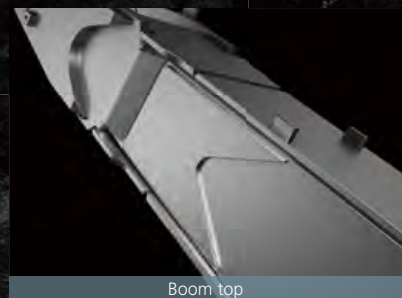

Boom top

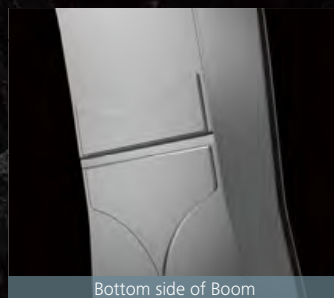

Bottom side of Boom

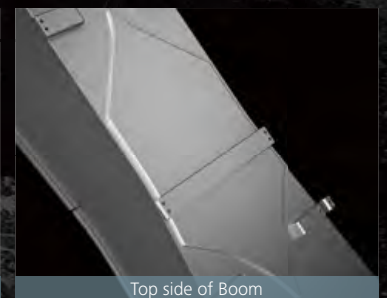

Top side of Boom



# Power Meets Efficiency for Increased Productivity

"Power" means increased productivity

Best-in-class drawbar pull delivers powerful tractive force, for easy transit over loose stones, while a highly reliable filtration system results in superior hydraulic performance for the life of the machine.

## An Undercarriage Built for Unbeatable Durability

### Reinforced Guide Frame ① **NEW**



Reinforced guide frame prevents deformation caused by impact or encroaching of loose stones.

### Reinforced Guide Frame ② **NEW**



Inside of guide frame is reinforced.

### Thicker Steel Plate for Shoes **NEW**



Reinforced HD shoes of thick steel plate to master rough, stony ground.

### Track Links **NEW**



The durability of the track link is increased compared to SK500LC-9.

### Lower Frame Underside Cover **NEW**



Hydraulic piping and equipment protected against damage from rubble and stony ground.





**SK500XD LC**

## Improved Filtration System Reliability

Clean, contaminant-free fuel and hydraulic fluid are essential for stable performance. The improved filtration systems reduce the risk of mechanical trouble and enhance longevity and durability.

### Fuel Filter

The pre-filter, with built-in water separator maximises filtering performance.

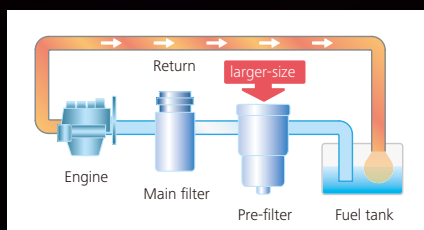

### Hydraulic Fluid Filter

Recognised as the best in the industry, our Premium-fine filter separates out even the smallest particles. A new cover prevents contamination when changing filters.

### Metal Mesh Cover Air Cleaner

Metal mesh cover ensures strength and durability.

### Hydraulic Fluid Filter Clog Detector

Hydraulic tank pressure sensor monitors the pressure difference between the return line and tank inside pressure to determine the degree of clogging. If the difference exceeds a predetermined level, a warning appears on the multi-display, so any contamination can be trapped by the filter and replaced before it reaches the hydraulic fluid in the tank.

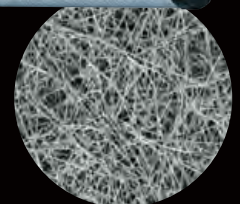
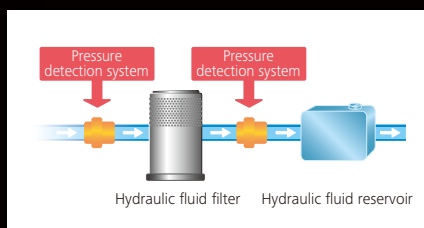

Enlarged filter image



# Proven Reliability and Improved Fuel Efficiency

"Efficiency" means proven low fuel consumption

The new arm interflow system more efficiently controls hydraulic fluid flow, and delivers a significant reduction of in-line resistance and pressure loss. This improves fuel efficiency.



## Hydraulic System: Revolutionary Technology Saves Fuel

### Arm Interflow System

When lowering the boom, this system uses the downward force generated by the boom's weight to push fluid to the shovel arm. This greatly reduces the need to apply power from outside the system.

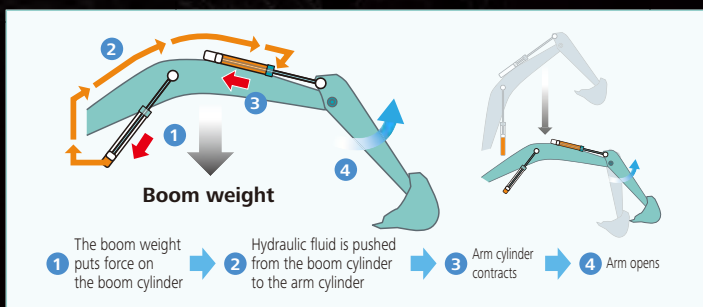

## In Pursuit of Improved Fuel Efficiency

### Operation Mode

Fuel consumption is lower in ECO-mode/H-mode/S-mode in comparison with the previous model (SK500LC-9).

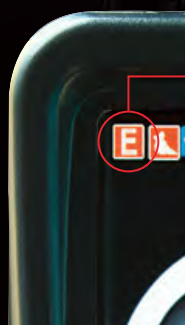

- E** Minimum fuel consumption for utility projects and other work that demands precision  
**ECO-mode, 13% decrease**
- H** Used to prioritise amount of work done  
**H-mode, 8% decrease**
- S** Used to strike a balance between workloads and fuel efficiency  
**S-mode, 8% decrease**





## Get More Output Faster with Superior Performance

### ME 2.6 m Arm

■ Max. Bucket Digging Force	■ Max. Digging Reach:
Normal: <b>282 kN</b>	<b>11,250 mm</b>
With Power Boost: <b>308 kN</b>	■ Max. Digging Depth:
	<b>6,820 mm</b>
■ Max. Arm Crowding Force	■ Max. Vertical Digging Depth:
Normal: <b>239 kN</b>	<b>6,090 mm</b>
With Power Boost: <b>261 kN</b>	

### 3.45 m Arm

■ Max. Bucket Digging Force	■ Max. Digging Reach:
Normal: <b>268 kN</b>	<b>12,040 mm</b>
With Power Boost: <b>293 kN</b>	■ Max. Digging Depth:
	<b>7,810 mm</b>
■ Max. Arm Crowding Force	■ Max. Vertical Digging Depth:
Normal: <b>203 kN</b>	<b>6,870 mm</b>
With Power Boost: <b>222 kN</b>	

### Top Class Tractive Force

Powerful tractive force and drawbar pulling force deliver plenty of speed when climbing slopes or negotiating rough terrain, and the agility to change direction swiftly and smoothly.

■ Drawbar Pulling Force: **415 kN**

Equipped with a 3.4 m<sup>3</sup> ME bucket, the maximum digging reach achieves 11,250 mm, resulting in a reach of over 11 m.

**NEW**

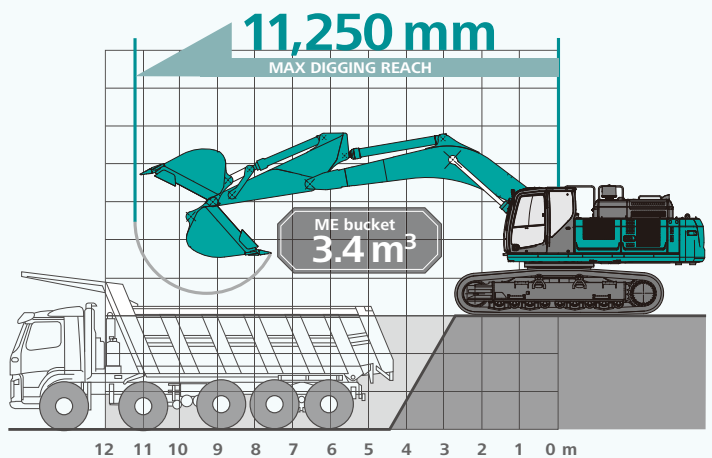

## Pursuing Maximum Fuel Efficiency

### AIS (Auto Idle Stop)

If the boarding/disembarking lever is left up, the engine will stop automatically. This eliminates wasteful idling during standby, saving fuel and reducing CO<sub>2</sub> emissions as well.

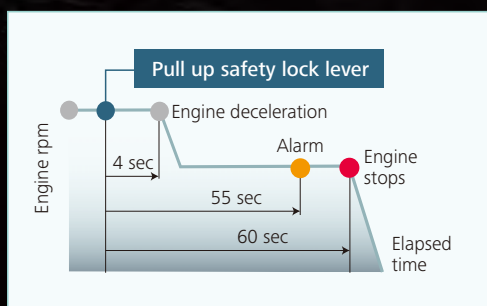

### Common Rail System

High-pressure injection atomises the fuel, and more precise injection improves combustion efficiency. This also contributes to better fuel economy.

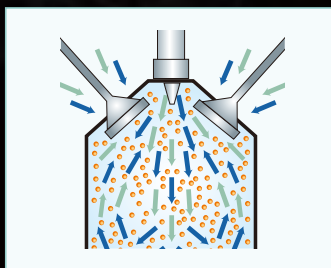

### EGR Cooler

While ensuring sufficient oxygen for combustion, cooled emission gases are mixed with the intake air and recirculated into the engine. This reduces oxygen content and lowers combustion temperature.

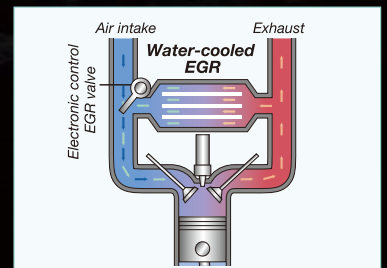



# A Cabin Designed for Operator Comfort and Visibility

A work environment that is quieter and more comfortable. A cab that puts the operator first is key to improved productivity.



## Air Conditioner Vents behind the Seat



The large air-conditioner has louvers on the back pillars that blow from behind and to the right and left of the operator's seat. They can be adjusted to put a direct flow of cool/warm air on the operator, which means a more comfortable operating environment.

## Super-Airtight Cab



The high level of air-tightness keeps dust out of the cab.

## Low Vibration

Coil springs absorb small vibrations, and high suspension mounts filled with silicone oil reduce heavy vibration. The long stroke achieved by this system provides excellent protection from vibration.

Twice the stroke of a conventional mount

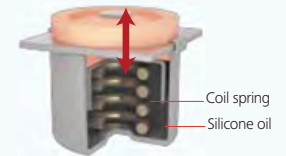

## Multi-Display in Colour

Brilliant colours and graphic displays are easy to recognise on the LCD multi-display in the console. The display shows fuel consumption, maintenance intervals, and more.



Fuel consumption

**MAINTENANCE**  
13.8h

	INTERVAL	REMAINING TIME	EXCHANGE DATE
ENGINE OIL	500	498	--/--
FUEL FILTER	500	498	--/--
HYD. FILTER	1000	998	--/--
HYD. OIL	5000	4998	--/--

Maintenance



Breaker mode

- 1 Analog gauge provides an intuitive reading of fuel level and engine water temperature
- 2 Green indicator light shows low fuel consumption during operation
- 3 Fuel consumption/Switch indicator for rear camera images
- 4 Digging mode switch
- 5 Monitor display switch

## One-Touch Attachment Mode Switch

A simple touch of a button, switches the hydraulic circuit and flow amount to match attachment changes. Icons help the operator to confirm the proper configuration at a glance.



## Comfort



### Clear View Helps the Operator

The front window features one large piece of glass without a center pillar on the right side for a wide, unobstructed view.

### Large Cab Is Easy to Get In and Out of

The expanded cab provides plenty of room for a large door, more headroom and smoother entry and exit.



## More Comfortable Seat Means Higher Productivity



Seat suspension absorbs vibration



Seat recliner can be pushed back flat

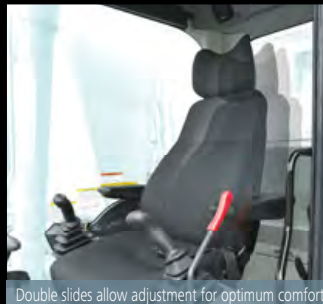

Double slides allow adjustment for optimum comfort

## A Light Touch on the Lever Means Smoother, Less Tiring Work



Pilot controlled joysticks have 25% lower lever effort\*, which reduces fatigue over long working hours or continued operations.

\*Compared to SK500LC-9

## Interior Equipment Adds to Comfort and Convenience



USB connector/12V power outlet

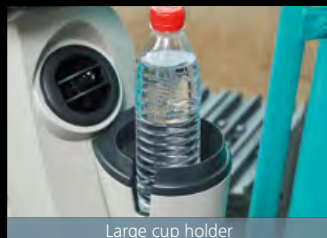

Large cup holder



Bluetooth® installed AM/FM stereo radio

## Safety

### ROPS Cab



ROPS (Roll-Over-Protective Structure)-compliant cab clears ISO standards (ISO-12117-2: 2008) and ensures greater safety for the operator should the machine tip over.

\*Top guard is fitted as standard.



### Expanded Field of View for Greater Safety

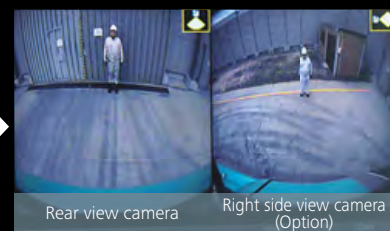

Rear view camera

Right side view camera (Option)

### Right Side Camera Fitted as Option

In addition to the existing rear view camera, an optional camera for the right side can be fitted, for easy safety checks around the machine.



Greater safety assured by rear view mirrors on left and right.



# Efficient Maintenance Keeps the Machine in Peak Operating Condition



MAINTENANCE				13.8h
	INTERVAL	REMAINING TIME	EXCHANGE DAY	
ENGINE OIL	500	498	--/--/--	
FUEL FILTER	500	498	--/--/--	
HYD. FILTER	1000	998	--/--/--	
HYD. OIL	5000	4998	--/--/--	

Examples of displaying maintenance information

## Machine Information Display Function

- Displays only the maintenance information that's needed, when it's needed
- Self-diagnostic function provides early-warning detection and display of electrical system malfunctions
- Service-diagnostic function makes it easier to check the status of the machine
- Record function of previous breakdowns including irregular and transient malfunction

## Easy, On-the-Spot Maintenance

There is ample space in the engine compartment for a mechanic to do maintenance work inside. The distance between steps is lower so entry and exit is easier. And the mechanic can work in comfort, without contortions or unnatural body positions. Finally, the hood is lighter and easier to raise and lower.



Step/Hand rail

## Daily Checks Made Simple, with Easy Ground Level Serviceability

The layout allows for easy access from the ground for many daily checks and regular maintenance tasks.



Fuel filter with built-in water-separator/Engine oil filter

Battery shut off switch



Left side

Right side

Simple layout for easy access to radiator and cooling system elements.

- 1 Engine oil filter
- 2 Pilot filter
- 3 Pump drain filter
- 4 Fuel filter with built-in water separator

## Easy Cleaning

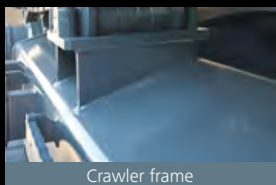

Crawler frame

Special crawler frame design for easy mud removal cleaning.



Detachable two-piece floor mat

Detachable two-piece floor mat with handles for easy removal. A floor drain is located under floor mat.



Floor mat with raised edges

Floor mat's raised edges help keep the cab floor free of mud, simplify cleaning.

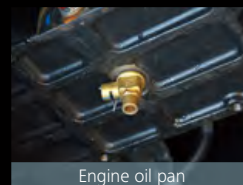

Engine oil pan

Engine oil pan equipped with drain valve.



Double-element air cleaner

## More Efficient Maintenance inside the Cab

Internal and external air conditioner filters can be easily removed without tools for cleaning.

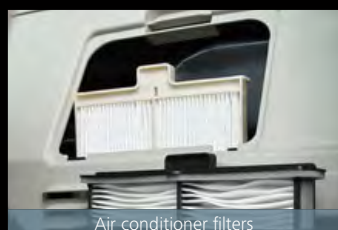

Air conditioner filters



# Specifications

## Engine

Model	HINO P11C-UP
Type	Water-cooled, 4-cycle 6-cylinder direct injection type diesel engine with intercooler turbo-charger
No. of cylinders	6
Bore and stroke	122 mm x 150 mm
Displacement	10.52 L
Rated power output	Net 257 kW/1,850 min <sup>-1</sup> (ISO 14396: without fan)
Max. torque	Net 1,400 N.m/1,400 min <sup>-1</sup> (ISO 14396: without fan)

## Hydraulic System

Pump	
Type	Two variable displacement pumps + One gear pump
Max. discharge flow	2 x 370 L/min Extra gear pump 60 L/min
Relief valve setting	
Excavating circuits (main)	31.4 MPa
Power Boost	34.3 MPa
Travel circuit	34.3 MPa
Swing circuit	26.0 MPa
Pilot control circuit	5.0 MPa
Pilot control pump	Gear type
Main control valve	8-spool
Oil cooler	Air cooled type

## Swing System

Swing motor	Axial piston motor
Brake	Hydraulic; locking automatically when the swing control lever is in neutral position
Parking brake	Wet multiple plate, hydraulic operated automatically
Swing speed	7.6 min <sup>-1</sup>

## Attachments

Backhoe bucket and combination

Use		Backhoe bucket		
		Heavy digging		Mass Excavating
Bucket capacity	ISO heaped m <sup>3</sup>	1.9	2.1	3.4
Opening width	With side cutters mm	1,470	1,570	1,900
	Without side cutters mm	1,370	1,470	1,810
No. of teeth		5	5	6
Bucket weight	kg	2,370	2,470	2,410
Combination	ME 6.5 m boom and ME 2.6 m arm	—	—	○
	3.0 m arm with 9,800 kg counterweight	○	○	—
	3.45 m arm with 9,800 kg counterweight	○	○	—

○ Recommended — Not applicable

## Travel System

Travel motors	Variable displacement piston pump
Travel brakes	Hydraulic
Parking brakes	Wet multiple plate
Travel shoes	50 each side
Travel speed (high/low)	5.4/3.4 km/h
Drawbar pulling force	415 kN
Gradeability	70% (35 deg)

## Cab & Control

Cab	
International Comfort Cab with dust free enclosure and with internal pressure of 97 Pa (earlier cab 27 Pa). All-weather, sound-suppressed steel cab mounted on the high suspension mounts filled with silicone oil and equipped with a heavy, insulated floor mat.	
Control	
Two hand levers and two foot pedals for travel	
Two hand levers for excavating and swing	
Electric rotary-type engine throttle	

## Boom, Arm & Bucket

Boom cylinders	170 mm x 1,590 mm	
Arm cylinder	190 mm x 1,970 mm	
Bucket cylinder	ME 2.6 m arm	170 mm x 1,429 mm
	3.0 m arm	160 mm x 1,410 mm
	3.45 m arm	160 mm x 1,410 mm

## Refilling Capacities & Lubrications

Fuel tank	638 L
Cooling system	47.4 L
Engine oil	42.5 L
Travel reduction gear	2 x 15 L
Swing reduction gear	2 x 5 L
Hydraulic oil tank	371 L tank oil level
	631 L hydraulic system



# Specifications



## Working Ranges

Unit: m

Boom	Arm	ME 6.5 m		7.0 m	
		ME 2.6 m	3.0 m	3.45 m	
Range					
a- Max. digging reach		11.25	11.69	12.04	
b- Max. digging reach at ground level		11.01	11.45	11.81	
c- Max. digging depth		6.82	7.36	7.81	
d- Max. digging height		11.12	10.85	10.81	
e- Max. dumping clearance		7.18	7.49	7.5	
f- Min. dumping clearance		3.07	3.23	2.78	
g- Max. vertical wall digging depth		6.09	6.58	6.87	
h- Min. swing radius		4.96	5.31	5.19	
i- Horizontal digging stroke at ground level		3.87	5.12	5.91	
j- Digging depth for 2.4 m (8') flat bottom		6.66	7.2	7.67	
Bucket capacity ISO heaped m <sup>3</sup>		3.4	2.1	1.9	

## Digging Force (ISO 6015)

Unit: kN

Arm length	ME 2.6 m	3.0 m	3.45 m
Bucket digging force	282/308*	267/292*	268/293*
Arm crowding force	239/261*	223/244*	203/222*

\*Power Boost engaged.

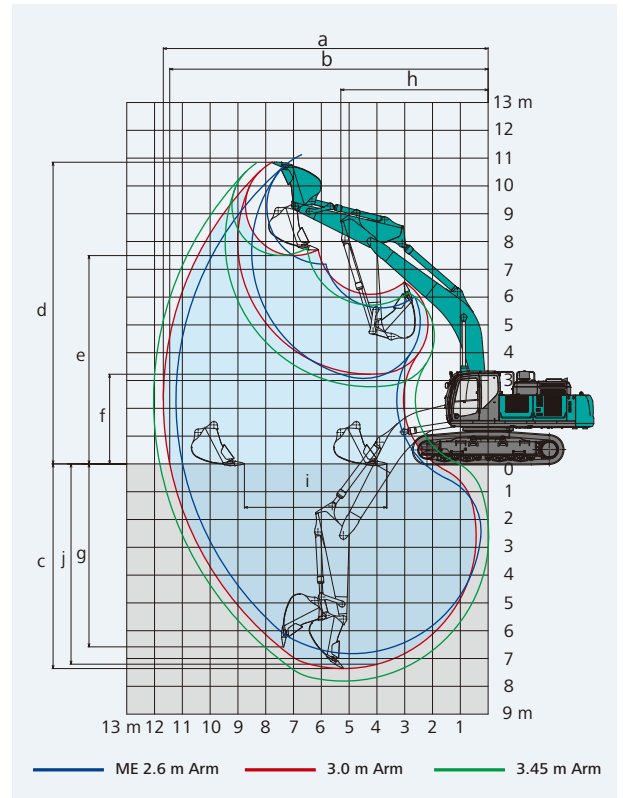

## Dimensions

Arm length	ME 2.6 m	3.0 m	3.45 m
A Overall length	12,060	12,210	12,230
B Overall height (to top of boom)	4,330	3,780	3,790
C Overall width		3,580	
D Overall height (to top of cab)		3,380	
E Ground clearance of rear end*		1,260*	
F Ground clearance*		510*	

Unit: mm		
G Tail swing radius	SK500XDLC	3,800
	SK520XDLC	3,880
G' Distance from center of swing to rear end	SK500XDLC	3,800
	SK520XDLC	3,880
H Tumbler distance		4,400
I Overall length of crawler		5,460
J Track gauge		2,750
K Shoe width		600
L Overall width of upperstructure		3,110

\*Without including height of shoe lug.

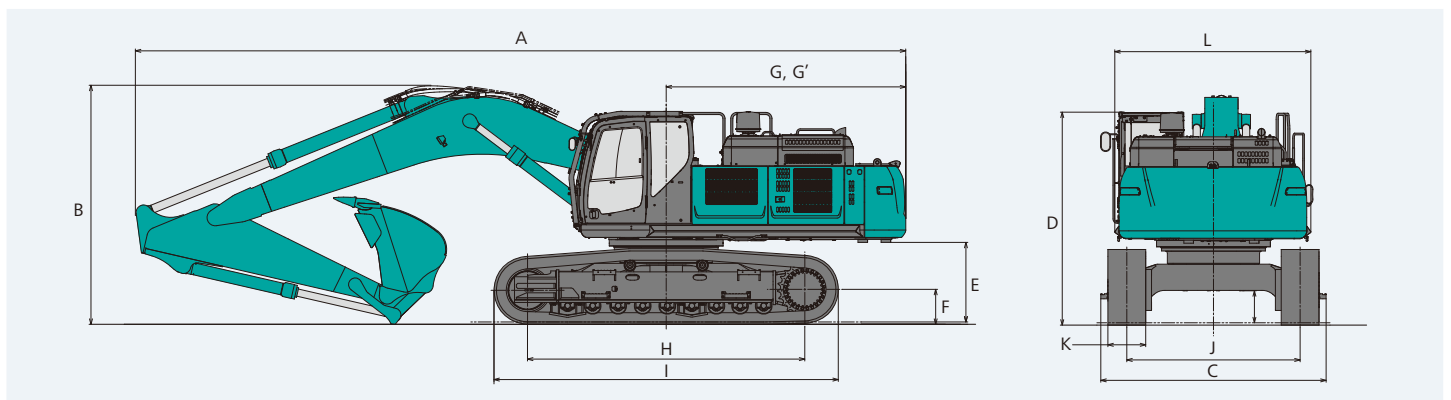

## Operating Weight & Ground Pressure

In standard trim, with ME 6.5 m boom, ME 2.6 m arm, 3.4 m<sup>3</sup> ISO heaped bucket, and 11,200 kg counterweight

Shaped		Triple grouser shoes (even height)	Double grouser shoes
Shoe width	mm	600	600
Overall width of crawler	mm	3,350	3,350
Ground pressure	kPa	92.1	91.8
Operating weight	kg	53,700	53,500

In standard trim, with 7.0 m boom, 3.45 m arm, 1.9 m<sup>3</sup> ISO heaped bucket, and 9,800 kg counterweight

Shaped		Triple grouser shoes (even height)	Double grouser shoes
Shoe width	mm	600	600
Overall width of crawler	mm	3,350	3,350
Ground pressure	kPa	89.4	89.1
Operating weight	kg	52,200	52,000



# Lift Capacities

**SK500XD<sub>LC</sub>**  
SK500XDLC-10

**SK520XD<sub>LC</sub>**  
SK520XDLC-10

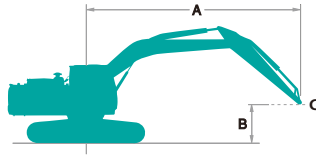

Rating over front



Rating over side or 360 degrees

A: Reach from swing centerline to arm top  
B: Arm top height above/below ground  
C: Lift point  
Relief valve setting: 34.3 MPa

SK500XDLC		Boom: 7.0 m Arm: 3.45 m Bucket: without Counterweight: 9,800 kg Shoe: 600 mm (Heavy Lift)												
A \ B		3.0 m		4.5 m		6.0 m		7.5 m		9.0 m		At Max. Reach		Radius
9.0 m	kg											*8,800	*8,800	7.72 m
7.5 m	kg											*8,320	*8,320	8.82 m
6.0 m	kg							*10,490	*10,490	*9,960	8,350	*8,170	7,490	9.56 m
4.5 m	kg			*17,800	*17,800	*13,610	*13,610	*11,550	10,780	*10,440	8,120	*8,260	6,780	10.01 m
3.0 m	kg			*22,430	21,080	*15,850	14,060	*12,790	10,240	*11,100	7,830	*8,580	6,400	10.23 m
1.5 m	kg			*18,340	*18,340	*17,700	13,250	*13,910	9,760	*11,730	7,550	*9,150	6,280	10.22 m
G.L.	kg			*21,230	19,370	*18,740	12,790	*14,660	9,440	*12,140	7,360	*10,070	6,400	9.98 m
-1.5 m	kg	*15,570	*15,570	*25,320	19,370	*18,900	12,620	*14,870	9,290	12,070	7,300	11,220	6,830	9.49 m
-3.0 m	kg	*24,510	*24,510	*23,730	19,610	*18,120	12,700	*14,280	9,340			*11,660	7,720	8.73 m
-4.5 m	kg	*27,600	*27,600	*20,750	20,120	*16,040	13,030	*12,120	9,680			*11,860	9,550	7.58 m

SK500XDLC		Boom: 7.0 m Arm: 3.0 m Bucket: without Counterweight: 9,800 kg Shoe: 600 mm (Heavy Lift)												
A \ B		3.0 m		4.5 m		6.0 m		7.5 m		9.0 m		At Max. Reach		Radius
9.0 m	kg											*10,620	*10,620	7.25 m
7.5 m	kg							*10,600	*10,600			*9,910	9,350	8.41 m
6.0 m	kg							*11,120	*11,120	*10,580	8,250	*9,650	7,950	9.18 m
4.5 m	kg			*19,330	*19,330	*14,400	*14,400	*12,120	10,670	*10,930	8,060	*9,710	7,170	9.65 m
3.0 m	kg					*16,550	13,850	*13,270	10,150	*11,490	7,800	*10,020	6,760	9.88 m
1.5 m	kg					*18,180	13,120	*14,270	9,710	*12,030	7,560	*10,650	6,640	9.86 m
G.L.	kg			*18,600	*18,600	*18,950	12,760	*14,870	9,440	*12,180	7,410	11,110	6,800	9.62 m
-1.5 m	kg	*14,690	*14,690	*24,800	19,490	*18,820	12,670	*14,870	9,350	*12,000	7,420	*11,760	7,300	9.11 m
-3.0 m	kg	*26,160	*26,160	*22,850	19,810	*17,720	12,830	*13,940	9,480			*12,010	8,370	8.31 m
-4.5 m	kg	*24,800	*24,800	*19,370	*19,370	*15,070	13,260					*11,930	10,650	7.10 m

SK520XDLC		Boom: ME 6.5 m Arm: ME 2.6 m Bucket: without Counterweight: 11,200 kg Shoe: 600 mm (Heavy Lift)												
A \ B		3.0 m		4.5 m		6.0 m		7.5 m		9.0 m		At Max. Reach		Radius
9.0 m	kg											*12,260	*12,260	6.24 m
7.5 m	kg											*10,660	*10,660	7.56 m
6.0 m	kg					*13,130	*13,130	*12,020	11,930			*9,930	9,800	8.41 m
4.5 m	kg					*14,890	*14,890	*12,750	11,530			*9,640	8,760	8.93 m
3.0 m	kg					*16,880	15,130	*13,730	11,060	*12,120	8,490	*9,660	8,250	9.17 m
1.5 m	kg					*18,400	14,450	*14,590	10,670	*12,380	8,330	*10,000	8,140	9.15 m
G.L.	kg					*19,030	14,110	*14,990	10,440			*10,700	8,420	8.88 m
-1.5 m	kg			*24,490	21,620	*18,620	14,080	*14,590	10,440			*12,000	9,220	8.34 m
-3.0 m	kg	*28,180	*28,180	*21,840	*21,840	*16,830	14,340					*12,220	10,920	7.45 m
-4.5 m	kg			*16,690	*16,690							*10,980	*10,980	6.06 m

## Notes:

- Do not attempt to lift or hold any load that is greater than these lift capacities at their specified lift point radius and heights. Weight of all accessories must be deducted from the above lift capacities.
- Lift capacities are based on machine standing on level, firm, and uniform ground. User must make allowance for job conditions such as soft or uneven ground, out of level conditions, side loads, sudden stopping of loads, hazardous conditions, experience of personnel, etc.
- Arm top defined as lift point.
- The above lift capacities are in compliance with ISO 10567. They do not exceed 87% of hydraulic lift capacity or 75% of tipping load. Lift capacities marked with an asterisk (\*) are limited by hydraulic capacity rather than tipping load.
- Operator should be fully acquainted with the Operator's and Maintenance Instructions before operating this machine. Rules for safe operation of equipment should be adhered to at all times.
- Lift capacities apply to only machine as originally manufactured and normally equipped by KOBELCO CONSTRUCTION MACHINERY CO., LTD.
- The above figures indicate machine capacity, but in practice the machine should not be used for lifting loads.



## STANDARD EQUIPMENT

## ENGINE

- Engine, HINO P11C-UP, diesel engine with turbocharger and intercooler
- Automatic engine deceleration
- Auto Idle Stop (AIS)
- Batteries (2 x 12 V - 112 Ah)
- Starting motor (24 V - 6 kW), 60 amp alternator
- Automatic engine shut-down for low engine oil pressure
- Engine oil pan drain valve
- Double element air cleaner
- Battery shut down
- Pre air cleaner
- Emergency engine shut-off switch

## CONTROL

- Working mode selector (H-mode, S-mode and ECO-mode)
- Power Boost
- Heavy Lift
- Boom and arm safety valve
- N&B piping (except for ME specification)

## BOOM, ARM &amp; BUCKET

- 7.0 m SHD boom
- 3.45 m SHD arm
- 6.5 m ME boom (only for SK520XDLC)
- 2.6 m ME arm (only for SK520XDLC)
- Bucketless

## SWING SYSTEM &amp; TRAVEL SYSTEM

- Swing rebound prevention system
- Two-speed travel with automatic shift down
- Sealed & lubricated track links
- Grease-type track adjusters
- 600 mm HD triple grouser shoe
- Lower under cover
- Travel alarm
- Automatic swing brake
- Tow eyes
- Track guides
- Straight propel system

## HYDRAULIC

- Arm interflow system
- Auto warm up system
- Aluminum hydraulic oil cooler
- Hydraulic fluid filter clog detector
- Quick hitch piping (except for ME specification)

## MIRRORS, LIGHTS &amp; CAMERA

- Two rear view mirrors, bottom clearance mirror
- Three front working lights (two for boom, one for right storage box)
- Rear view camera

## CAB &amp; CONTROL

- Two control levers, pilot-operated
- Horn, electric
- Cab light (interior)
- Luggage tray
- Large cup holder
- Detachable two-piece floor mat
- Headrest
- Handrails
- Intermittent windshield wiper with double-spray washer
- Skylight
- Tinted safety glass
- Pull-up type front window and removable lower front window
- Easy-to-read multi-display color monitor
- Automatic air conditioner
- Emergency escape hammer
- Air suspension seat
- 12 V outlet
- Bluetooth® installed AM/FM stereo radio
- USB pin
- TOP guard (ISO 10262:1998)
- GEOSCAN
- Heavy counterweight for ME specification

## OPTIONAL EQUIPMENT

- |                                     |                                 |  |   |
|-------------------------------------|---------------------------------|--|---|
| ■ 3.0 m SHD arm                     | ■ 600 mm HD double grouser shoe | ■ Refilling pump                             | ■ N&B piping for ME specification                       |
| ■ 1.9 m <sup>3</sup> full HD bucket | ■ Front guard                   | ■ Pattern changer                            | ■ Hydraulic pressure adjustment function for N&B piping |
| ■ 2.1 m <sup>3</sup> full HD bucket | ■ Rotatory beacon               | ■ Additional track guide                     | ■ Rain visor (may interfere with bucket action)         |
| ■ 3.4 m <sup>3</sup> ME bucket      | ■ Right side view camera        | ■ Extra piping (except for ME specification) | ■ Two cab lights  |

Note: Standard and optional equipment may vary. Consult your KOBELCO dealer for specifics. Bluetooth® is a registered trademark of the Bluetooth SIG Inc.

## EXCAVATOR REMOTE MONITORING SYSTEM

The GEOSCAN Remote Monitoring System is a satellite and cellular based system for remotely monitoring machine information and managing routine maintenance. Manage your machines anywhere in the world, with location, workload, maintenance information and diagnostic data available 24/7 via the GEOSCAN website.

## Direct Access to Operational Status

## Location Data

Accurate location data can be obtained even from sites where communications are difficult.

## Operating Hours

A comparison of operating times of machines at multiple locations shows which locations are busier and more profitable. Operating hours on site can be accurately recorded, for running time calculations needed for rental machines, etc.

## Fuel Consumption Data

Data on fuel consumption and idling times can be used to indicate improvements in fuel consumption.

## Graph of Work Content

The graph shows how working hours are divided among different operating categories, including digging, idling, traveling, and hydraulic attachment use.



## Maintenance Data and Warning Alerts

## Machine Maintenance Data

Provides maintenance status of separate machines operating at multiple sites. Maintenance data is also relayed to KOBELCO service personnel, for more efficient planning of periodic servicing.

## Security System

## Engine Start Alarm

Sends a notification if the engine is started outside of pre-defined hours.

## Area Alarm

Sends a notification if the machine leaves a pre-defined area.

Note: Remote monitoring system is not applicable in some area due to country regulation of the communication lines or availability of infrastructure.

Note: This catalog may contain attachments and optional equipment that are not available in your area. And it may contain photographs of machines with specifications that differ from those of machines sold in your areas. Please consult your nearest KOBELCO distributor for those items you require. Due to our policy of continuous product improvements all designs and specifications are subject to change without advance notice. Copyright by **KOBELCO CONSTRUCTION MACHINERY CO., LTD.** No part of this catalog may be reproduced in any manner without notice.

## KOBELCO CONSTRUCTION MACHINERY CO., LTD.

5-15, Kitashinagawa 5-chome, Shinagawa-ku, Tokyo 141-8626 JAPAN  
Tel: +81 (0) 3-5789-2146 Fax: +81 (0) 3-5789-2135  
<https://www.kobelcocm-global.com/>

Inquiries To: